

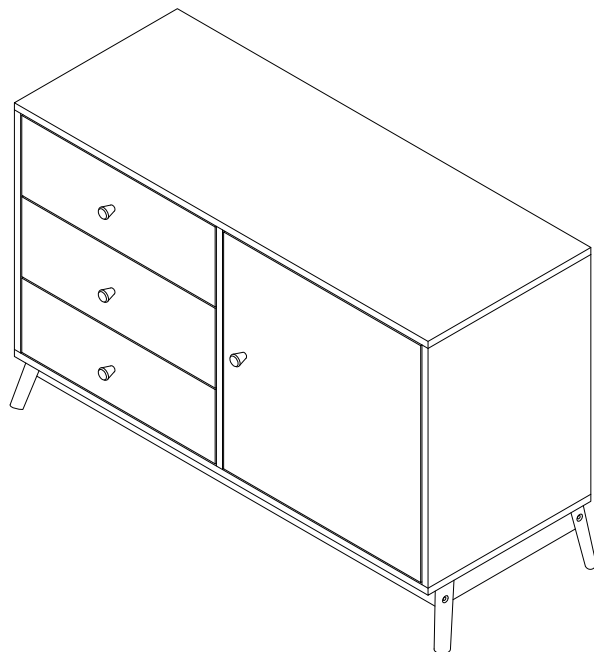

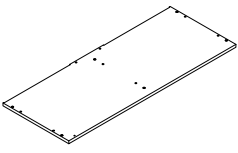

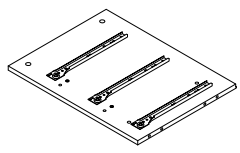

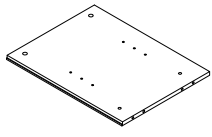

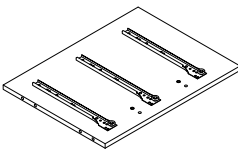
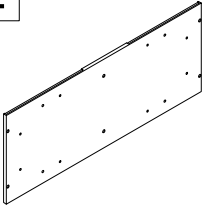
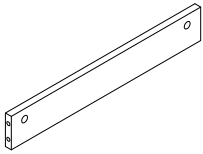
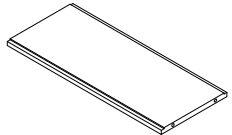
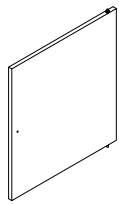
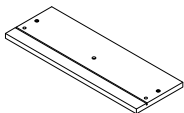
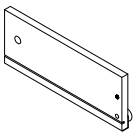
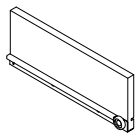
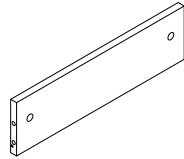
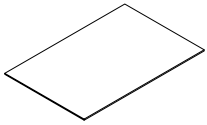
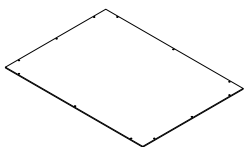
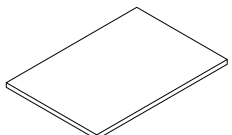
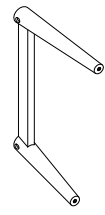
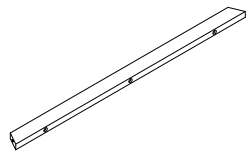



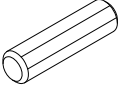

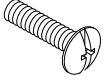
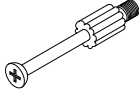
Media Console
CF1118

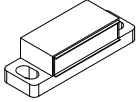

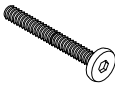
PART LIST

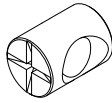
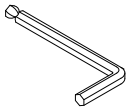
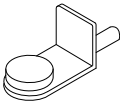
<p>A</p> 	<p>B</p> 	<p>C</p> 	<p>D</p> 	<p>E</p> 
<p>Top Panel 1 PC</p>	<p>Left Panel 1 PC</p>	<p>Right Panel 1 PC</p>	<p>Partition Panel 1 PC</p>	<p>Bottom Panel 1 PC</p>
<p>F</p> 	<p>G</p> 	<p>H</p> 	<p>I</p> 	<p>J</p> 
<p>Cross Rail 2 PCS</p>	<p>Back Middle Brace 1 PC</p>	<p>Door Panel 1 PC</p>	<p>Drawer Front Panel 3 PCS</p>	<p>Drawer Left Panel 3 PCS</p>
<p>K</p> 	<p>L</p> 	<p>M</p> 	<p>N</p> 	<p>O</p> 
<p>Drawer Right Panel 3 PCS</p>	<p>Drawer Back Panel 3 PCS</p>	<p>Drawer Bottom Panel 3 PCS</p>	<p>Back Panel 2 PCS</p>	<p>Adjustable Shelf 1 PC</p>
<p>P</p> 	<p>Q</p> 			
<p>Side Frame 2 PCS</p>	<p>Rail 2 PCS</p>			

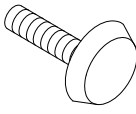
HARDWARE LIST

<p>#1</p>  <p>Ø8*30mm</p>	<p>#2</p> 	<p>#3</p>  <p>3/4"*Ø5/32"</p>	<p>#4</p> 	<p>#5</p> 
<p>Wood Dowel 40 PCS (Extra 1)</p>	<p>Knob 4 PCS</p>	<p>Round Head Bolt 4 PCS</p>	<p>Cam Bolt 22 PCS</p>	<p>Cam Lock 22 PCS (Extra 1)</p>
<p>#6</p> 	<p>#7</p> 	<p>#8</p>  <p>3-1/2"*Ø1/4"*D11mm</p>	<p>#9</p>  <p>2"*Ø1/4"*D11mm</p>	<p>#10</p> 
<p>Magnet 1 PC</p>	<p>Round Head Screw 2 PCS (Extra 1)</p>	<p>Long Bolt 6 PCS</p>	<p>Short Bolt 10 PCS</p>	<p>Barrel Nut 6 PCS</p>
<p>#11</p> 	<p>#12</p> 	<p>#13</p> 	<p>#14</p> 	<p>#15</p> 
<p>Allen Wrench 1 PC</p>	<p>Shelf Holder 4 PCS</p>	<p>Screw 24 PCS (Extra 1)</p>	<p>Adjustable Leveler 4 PCS</p>	<p>Safety Strap Kit 1 SET</p>

ADDITIONAL TOOLS (Not Provided)

Note: It is not recommended to use power tools during assembly.

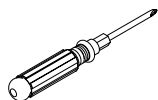

Phillips Head Screwdriver

Note: Wood dowels are intended for alignment. Additional clearance between wood dowel and pre-drilled hole is intentional for ease of assembly.

Step 1. Attach cam bolts (part #4) to top panel (part A), left panel (part B), partition panel (part D), drawer front panels (part I), drawer left panels (part J) and drawer right panels (part K) using phillips head screwdriver.

NOTE: Do not overtighten cam bolts. Stop tightening once threads on cam bolt are no longer visible.

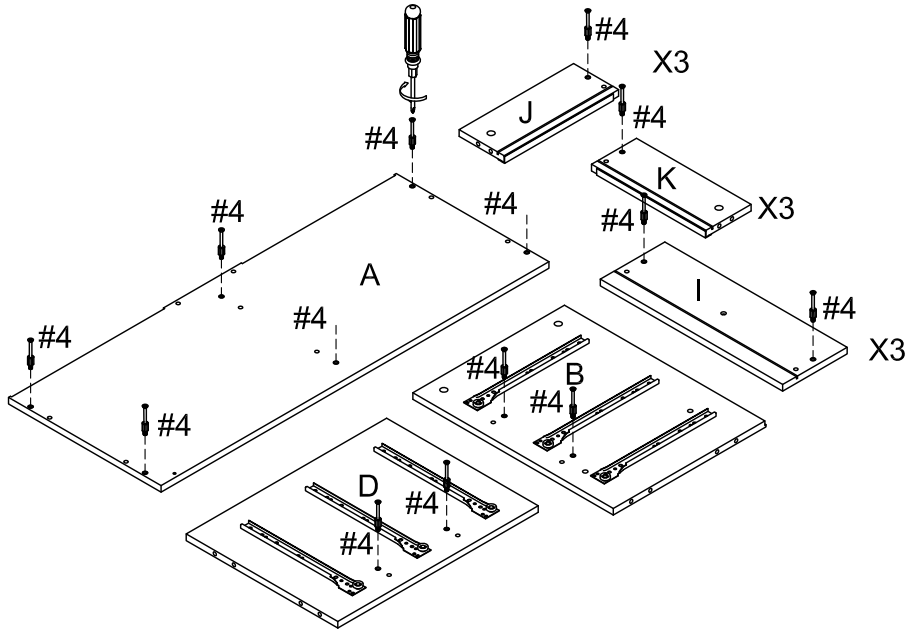

#4  x 22

Step 2. Attach knobs (part #2) to drawer front panels (part I) and door panel (part H) using round head bolts (part #3) and phillips head screwdriver. Attach magnet (part #6) to partition panel (part D) using round head screws (part #7) and phillips head screwdriver.

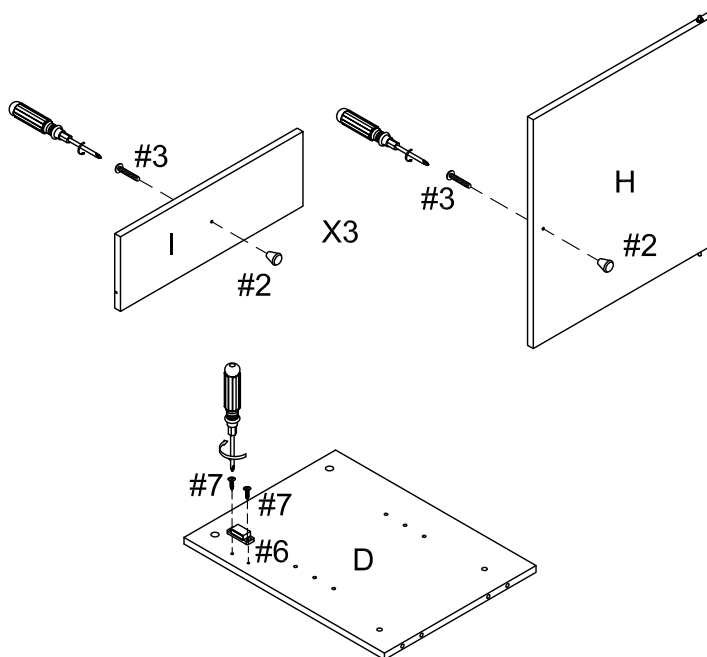

#2  x 4
 #3  x 4
 #6  x 1
 #7  x 2

Step 3. Attach drawer panels (parts J & K) to drawer back panel (part L) using wood dowels (part #1) and cam locks (part #5). Slide drawer bottom panel (part M) into grooves of assembled unit (parts J, K & L). Attach drawer front panel (part I) to assembled unit (parts J, K & M) using wood dowels (part #1) and cam locks (part #5). Repeat for remaining drawers.

NOTE: Cam locks must rotate a full 180°. See pictured insert.

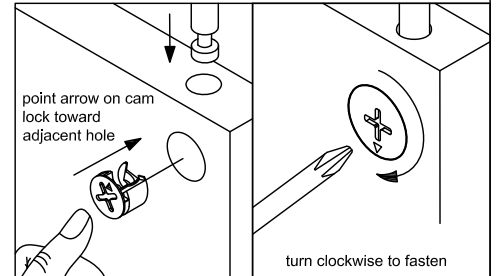
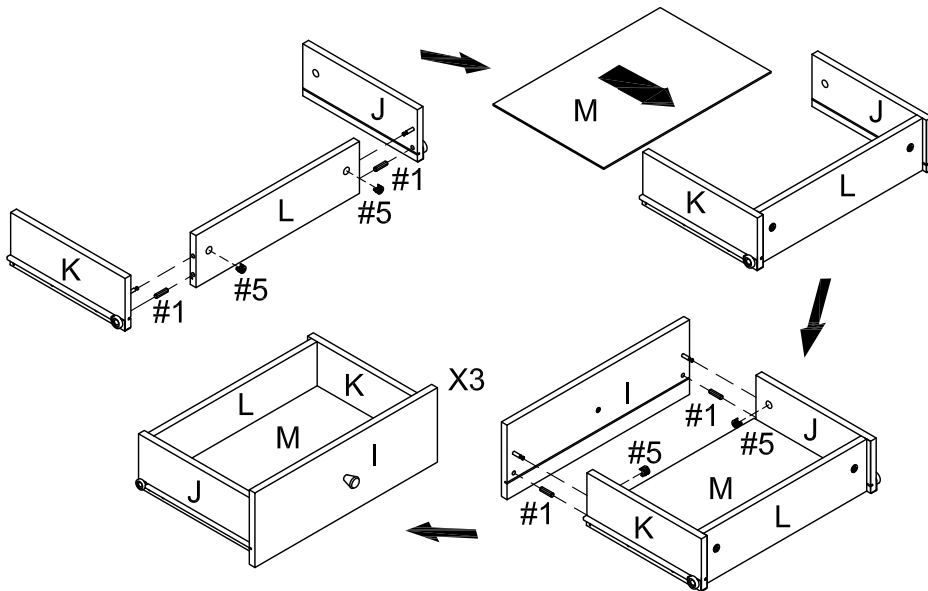

#1  x 12
 #5  x 12

Step 4. Attach cross rails (part F) to left panel (part B) and partition panel (part D) using wood dowels (part #1) and cam locks (part #5).



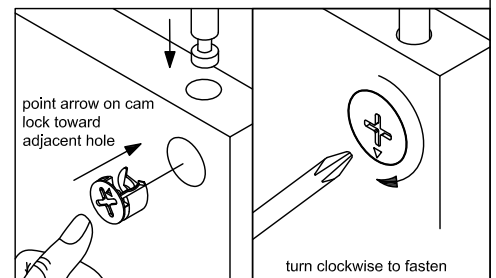
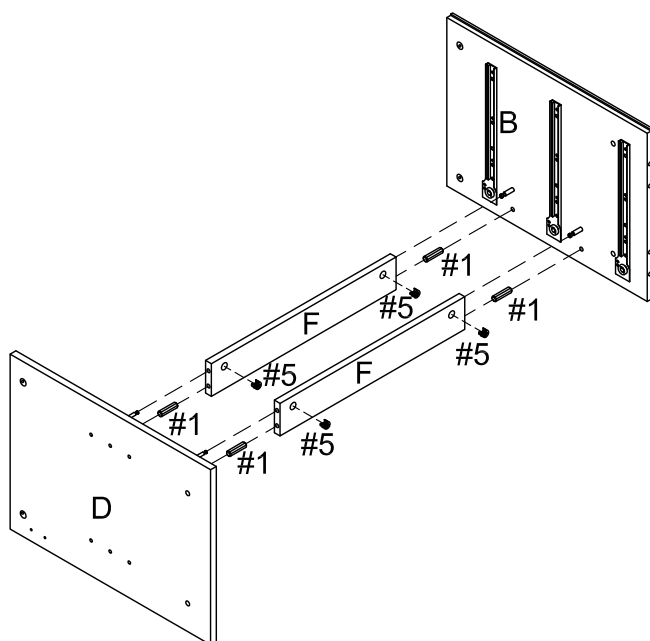

NOTE: Cam locks must rotate a full 180°. See pictured insert.

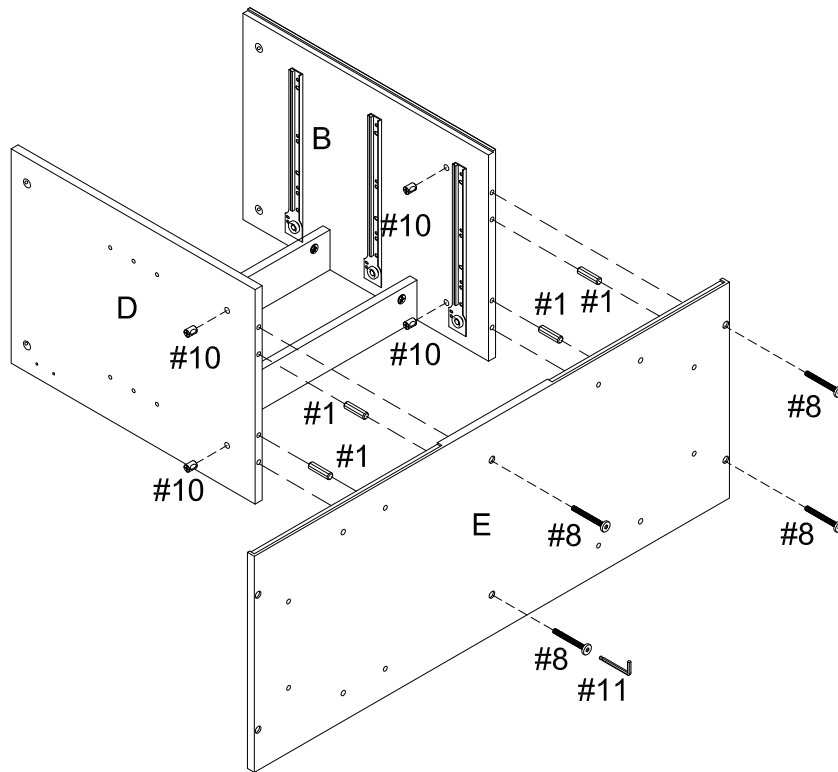

#1  x 4
 #5  x 4





Step 5. Attach bottom panel (part E) to assembled unit (parts B & D) using wood dowels (part #1), long bolts (part #8), barrel nuts (part #10) and allen wrench (part #11).

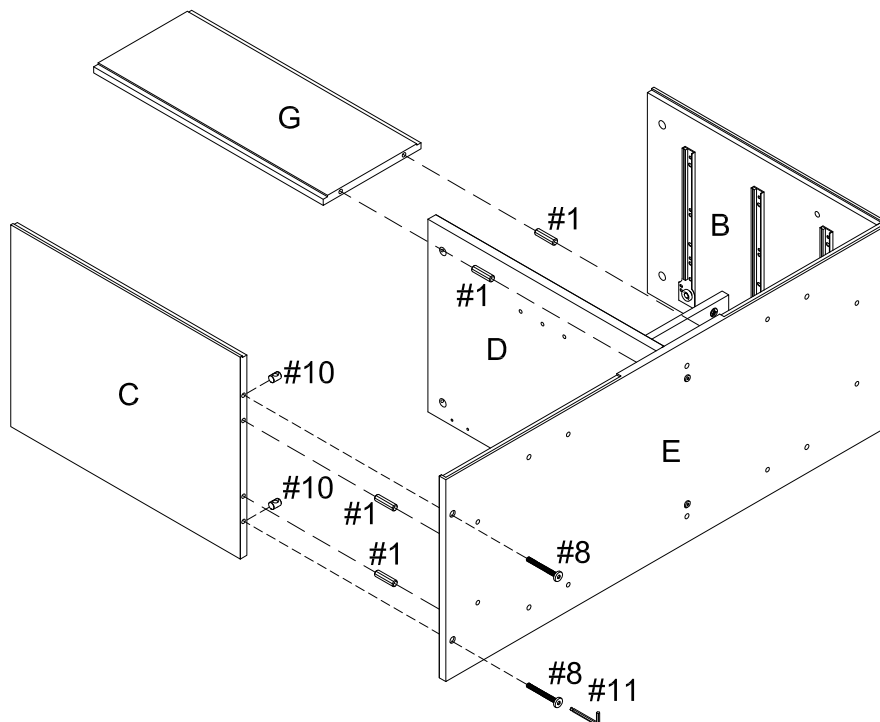

- #1  x 4
- #8  x 4
- #10  x 4
- #11  x 1

Step 6. Attach right panel (part C) and back middle brace (part G) to bottom panel (part E) using wood dowels (part #1), long bolts (part #8), barrel nuts (part #10) and allen wrench (part #11).



- #1  x 4
- #8  x 2
- #10  x 2
- #11  x 1

Step 7. Attach top panel (part A) to assembled unit (parts B, C, D & G) using wood dowels (part #1) and cam locks (part #5).

NOTE: Cam locks must rotate a full 180°. See pictured insert.

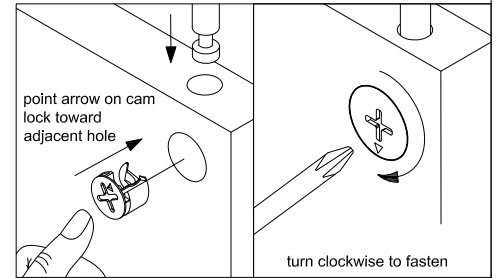
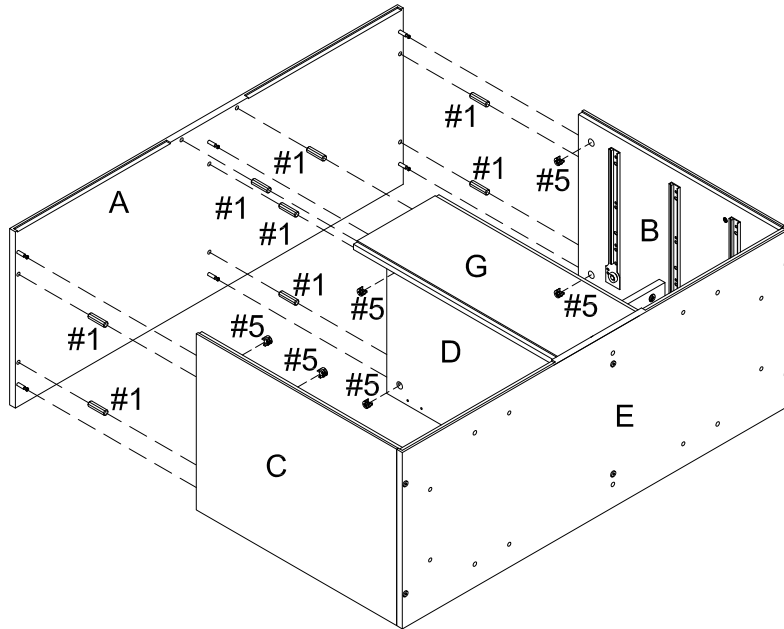

#1  x 8
 #5  x 6

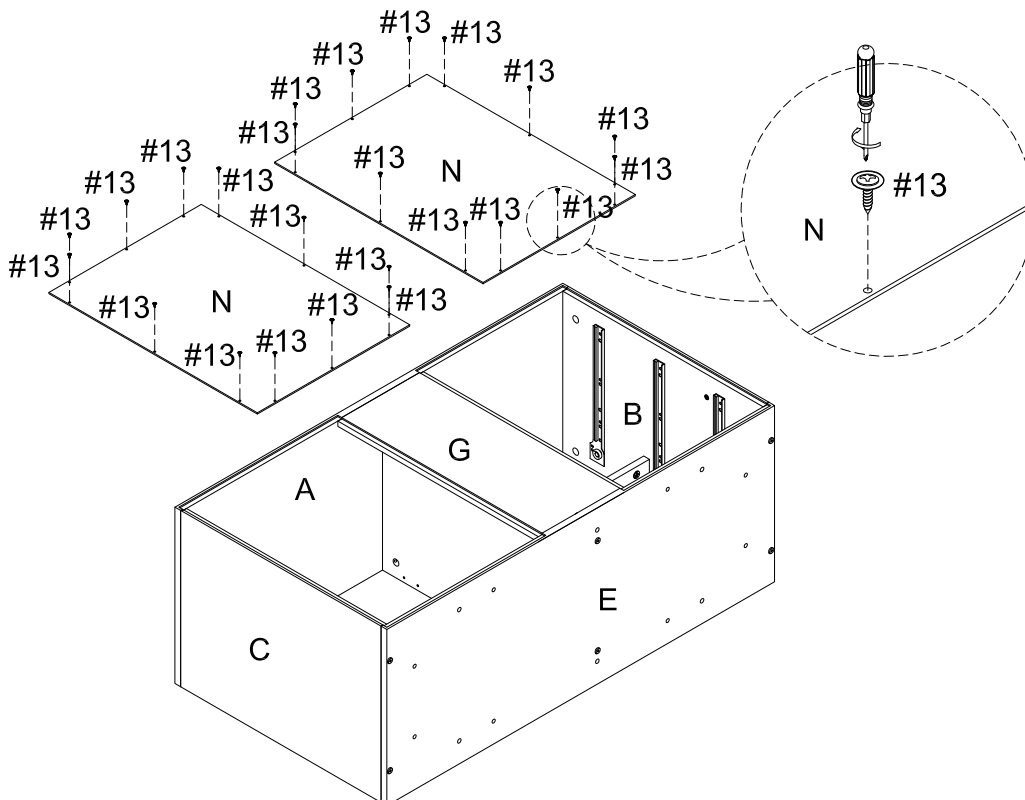

Step 8. Attach back panels (part N) to assembled unit (parts A, B, C, E & G) using screws (part #13) and phillips head screwdriver.



#13  x 24

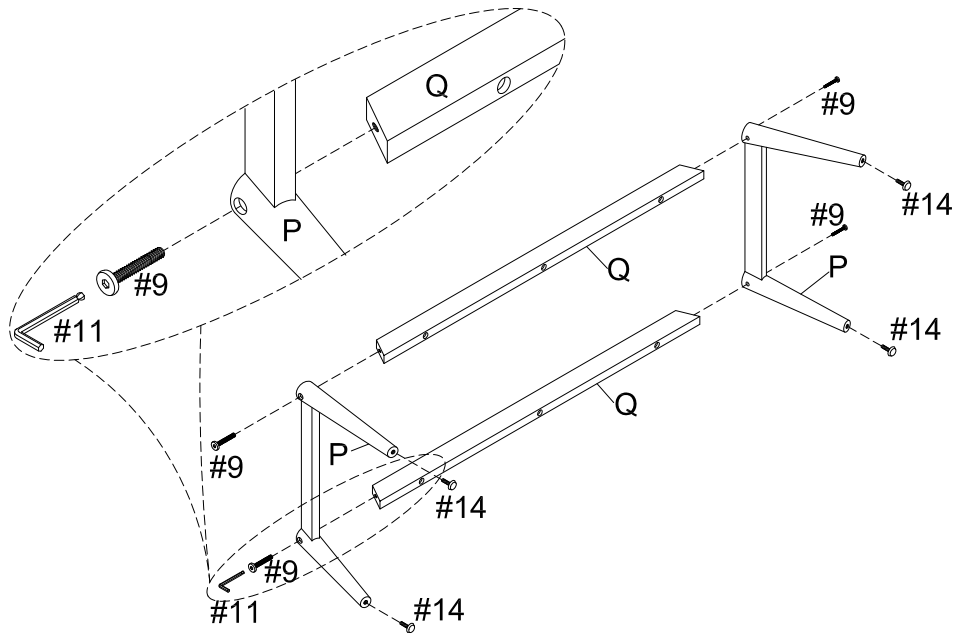

Step 9. Attach rails (part Q) to side frames (part P) using short bolts (part #9) and allen wrench (part #11). Attach adjustable levelers (part #14) to side frames (part P).

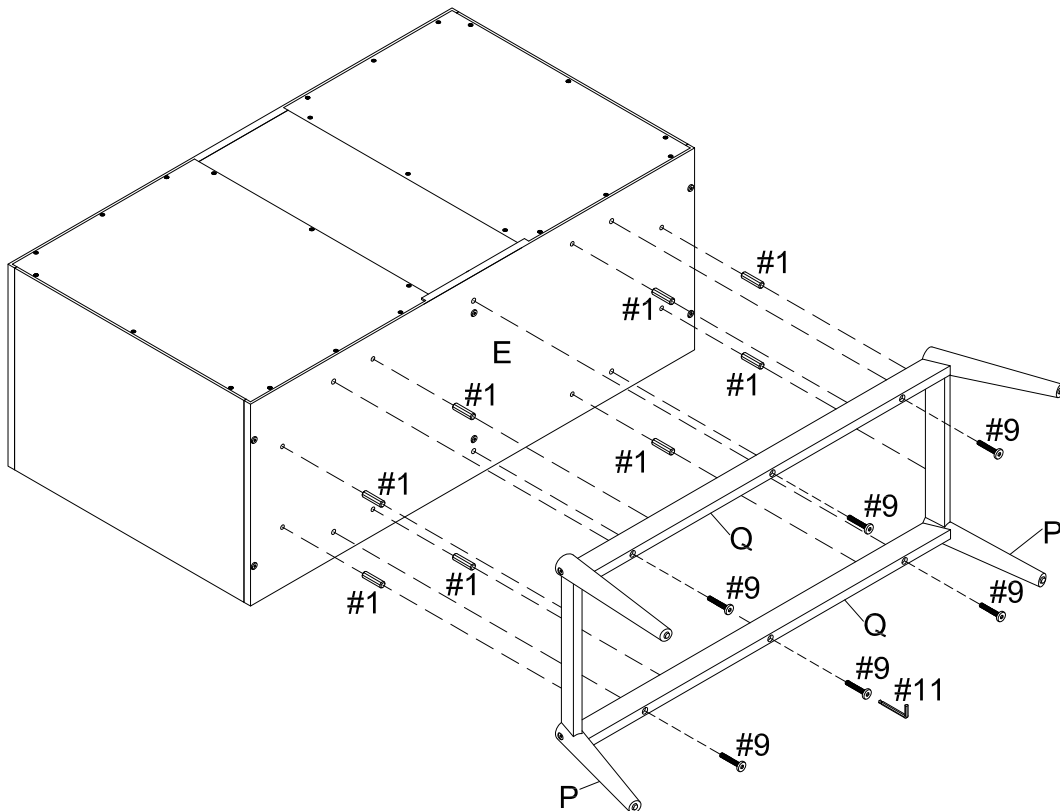

#9  x 4
 #11  x 1
 #14  x 4

Step 10. Attach assembled unit (parts P & Q) to bottom panel (part E) using wood dowels (part #1), short bolts (part #9) and allen wrench (part #11).



#1  x 8
 #9  x 6
 #11  x 1

Step 11. Carefully turn unit upright. Place shelf holders (part #12) into desired position and then slide adjustable shelf (part O) into place. Slide assembled drawers into place.

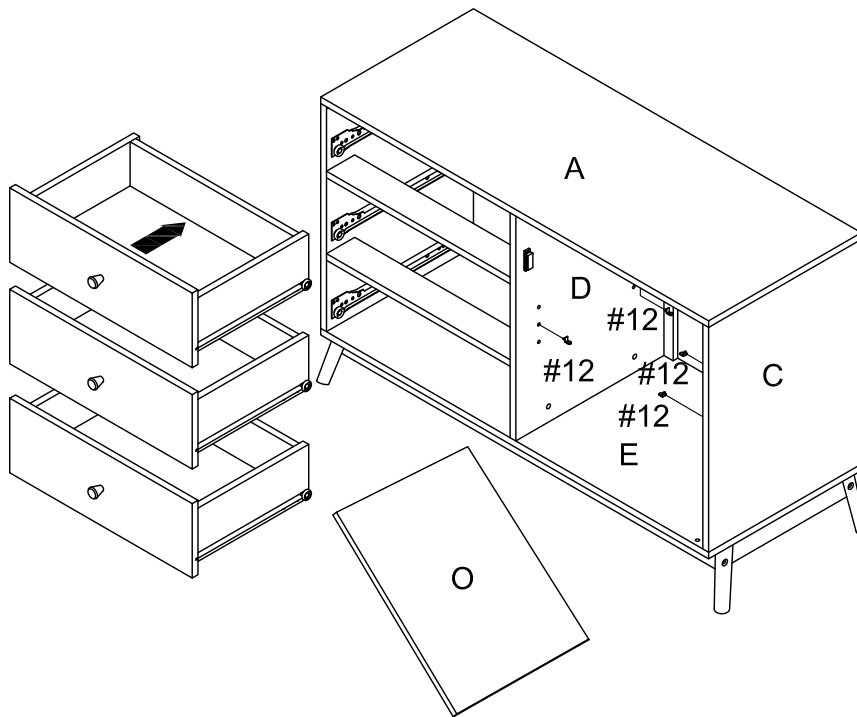

#12 \times 4



Step 12. Attach door panel (part H) by placing bottom pin hinge (pre-installed in door) in the pre-drilled hole of bottom panel (part E). Then depress the top spring-loaded pin hinge so it can be placed in the pre-drilled hole of top panel (part A).

NOTE: Be sure top and bottom pin hinges are fully extended to secure door in place.

NOTE: It is important to adjust levelers once fully assembled and upright. Extend adjustable leveler until it's firmly in contact with the floor. If relocating, adjust leveler as needed until it's firmly in contact with the floor in new location.

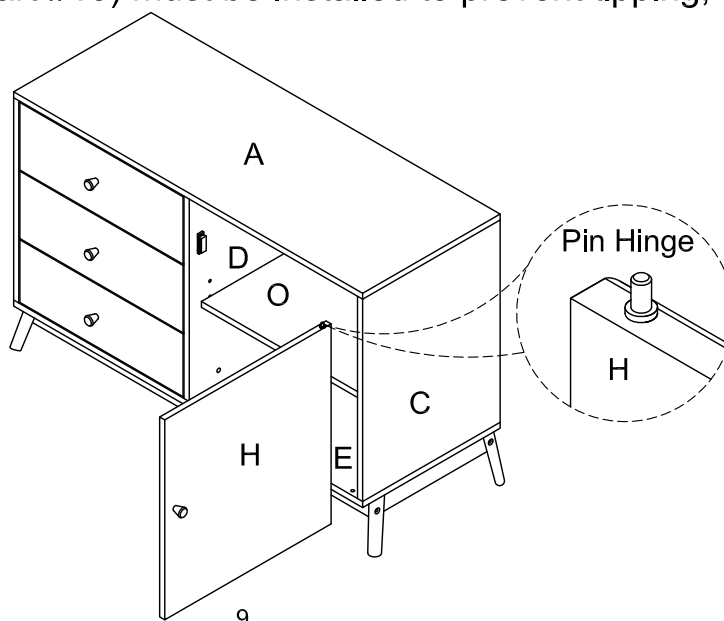
Important: Safety strap kit (part #15) must be installed to prevent tipping, damage and/or injury.

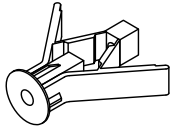

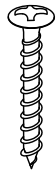
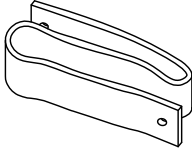
#15 	A 	B 	C  D8*3/4"	D  D8*1-1/2"	E 
Safety Strap Kit 1 SET	Wall Anchor 1 PC	Washer 2 PCS	Short Screw 1 PC	Long Screw 1 PC	Safety Wall Strap 1 PC

SAFETY WALL STRAP INSTALLATION

Note: It is highly recommended to install this safety strap kit to prevent tipping, damage and/or injury.

1. Insert short screw (C) through washer (B) and safety wall strap (E) and attach to top panel (part A) using phillips head screwdriver.

2. Drill a 11/32" hole where you want to secure the unit. The drilled hole will be at the same height as the hole in top panel (part A) where the safety wall strap (E) is attached. Tap wall anchor (A) into the hole.

3. Insert long screw (D) through washer (B) and safety wall strap (E) into wall anchor (A) using phillips head screwdriver.

Note: This item is not intended for clothing storage use.

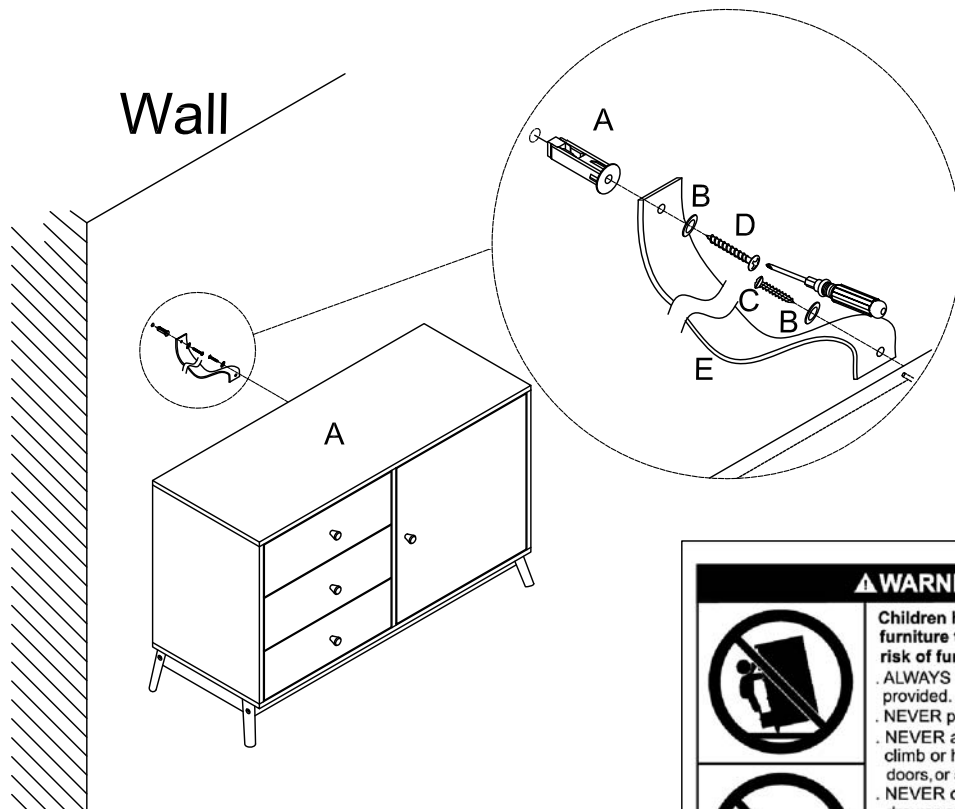

▲ WARNING	
	<p>Children have died from furniture tipover. To reduce the risk of furniture tipover:</p> <ul style="list-style-type: none"> · ALWAYS install tipover restraint provided. · NEVER put a TV on this product. · NEVER allow children to stand, climb or hang on drawers, doors, or shelves. · NEVER open more than one drawer at a time. · Place heaviest items in the lowest drawers.
	<p style="text-align: center;"><i>This is a permanent label. Do not remove!</i></p>